

LABORATÓRIUMI ÜVEG ESZKÖZÖK KATALÓGUSA

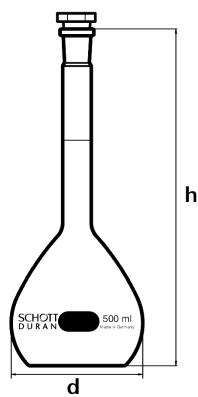

Mérőolombik, A osztályú, NS üveg dugóval



Kód	Kód barna	Térfogat (ml)	Hibahatár (\pm ml)	NS
31 664 000	31 671 000	5	0,025	7/16
31 664 001	31 671 001	10	0,04	7/16
31 664 002	31 671 002	20	0,04	10/19
31 664 003	31 671 003	25	0,04	10/19
31 664 005	31 671 005	50	0,06	12/21
31 664 010	31 671 010	100	0,1	12/21
31 664 020	31 671 020	200	0,15	14/23
31 664 025	31 671 025	250	0,15	14/23
31 664 050	31 671 050	500	0,25	19/26
31 664 100	31 671 100	1000	0,4	24/29
31 664 200	31 671 200	2000	0,6	29/32
31 664 500	31 671 500	5000	1,2	34/35

Mérőlombik, B osztályú, NS dugóval

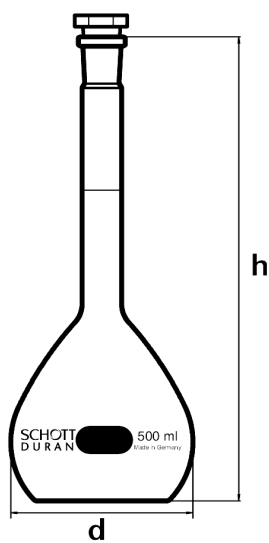

Kód	Térfogat (ml)	Hibahatár (\pm ml)
21 678 07 H	5	0,05
21 678 08 H	10	0,08
21 678 14 H	25	0,08
21 678 17 H	50	0,12
21 678 24 H	100	0,2
21 678 32 H	200	0,3
21 678 36 H	250	0,3
21 678 44 H	500	0,5
21 678 54 H	1000	0,8
21 678 63 H	2000	1,2
21 678 73 H	5000	2,4

Mérőhenger üvegtalppal, osztással, B osztályú

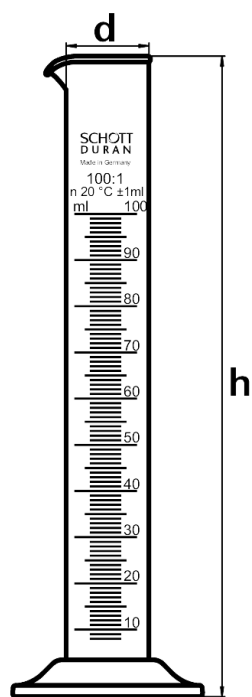

Kód	Térfogat (ml)	Hibahatár (\pm ml)	h (mm)	d (mm)
21 396 08 H	10	0,2	137	14
21 396 14 H	25	0,5	167	21
21 396 17 H	50	1,0	196	25
21 396 24 H	100	1,0	256	29
21 396 36 H	250	2,0	331	39
21 396 44 H	500	5,0	360	53
21 396 54 H	1000	10,0	460	65
21 396 63 H	2000	20,0	500	85

Mérőhenger üvegtalppal, A osztályú

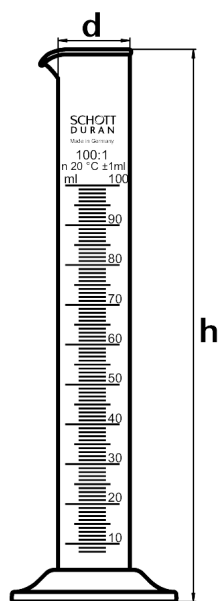

Kód	Térfogat (ml)	Hibahatár (\pm ml)	h (mm)	d (mm)
31 715 001	10	0,1	137	14
31 715 003	25	0,25	167	21
31 715 005	50	0,5	196	25
31 715 010	100	0,5	256	29
31 715 025	250	1,0	331	39
31 715 050	500	2,5	360	53
31 715 100	1000	5,0	460	65

Mérőhenger, műanyagtalppal

Kód	Térfogat (ml)
21 389 08 H	10
21 389 14 H	25
21 389 17 H	50
21 389 24 H	100
21 389 36 H	250
21 389 44 H	500
21 389 54 H	1000

Büretta, oldalcsapos, Schellbach csíkkal, főpontok körosztással, DIN AS osztály, teflonszeleppel

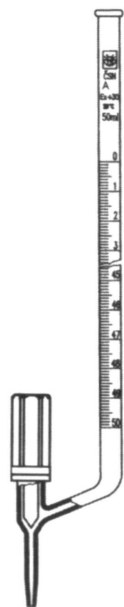

Kód	Térfogat (ml)	Osztás (ml)	Kifolyási idő (s)	Hibahatár (\pm ml)	Összes hossz (mm)
33 002 105A	10	0,02	35-45	0,02	750
33 002 255A	25	0,05	35-45	0,03	750
33 002 505A	50	0,1	35-45	0,05	750

Büretta, Schellbach csíkkal, B osztály

Kód teflonszelep	Kód üvegcsapos	Térfogat (ml)	Osztás (ml)	Hibahatár (\pm ml)
33 002 105	33 002 104	10	0,02	0,03
33 002 255	33 002 254	25	0,05	0,04
33 002 505	33 002 504	50	0,1	0,08

Automata büretta, 2000 ml-es fehér üvegtartállyal, B osztályú

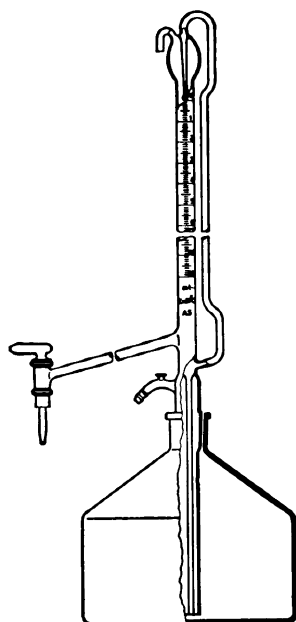

Kód tefloncsapos	Kód üvegcsapos	Térfogat (ml)	Osztás (ml)	Hibahatár (\pm ml)
33 102 105	33 102 104	10	0,02	0,03
33 102 255	33 102 254	25	0,05	0,04
33 102 505	33 102 504	50	0,1	0,08

Automata buretta, 2000 ml-es fehér üvegtartállyal, A osztályú

Kód tefloncsapos	Térfogat (ml)	Osztás (ml)	Hibahatár (\pm ml)
33 102 105A	10	0,02	0,02
33 102 255A	25	0,05	0,03
33 102 505A	50	0,1	0,05

Büretta edény, 2000 ml

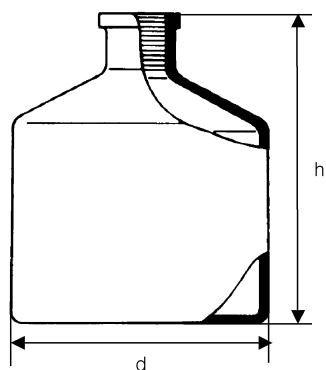

Kód	Szín
24 317 01 H	barna
24 317 02 H	fehér

Mérőpipetta, A osztály, főpontok körjelzéssel, 1 - jelű, német hit. jellel



Kód	Térfogat (ml)	Osztás (ml)	Hibahatár (\pm ml)
33 510 011	0,1	0,001	0,001
33 510 021	0,2	0,001	0,002
33 510 051	0,5	0,01	0,005
33 510 101	1	0,01	0,007
33 510 201	2	0,01	0,01
33 510 202	2	0,02	0,01
33 510 505	5	0,05	0,03
33 510 710	10	0,1	0,05
33 510 810	20	0,1	0,1
33 510 910	25	0,1	0,1
33 510 950	50	0,2	0,2

Mérőpipetta, B osztály, 1 – jelű



Kód	Térfogat (ml)	Osztás (ml)	Hibahatár (\pm ml)
33 500 011	0,1	0,001	0,002
33 500 021	0,2	0,001	0,004
33 500 051	0,5	0,01	0,01
33 500 101	1	0,01	0,014
33 500 201	2	0,01	0,02
33 500 202	2	0,02	0,02
33 500 505	5	0,05	0,06
33 500 710	10	0,1	0,1
33 500 810	20	0,1	0,2
33 500 910	25	0,1	0,2
33 500 950	50	0,2	0,4

Hasas pipetta, A osztály, 1 - jelű, német hitelesítési jellel

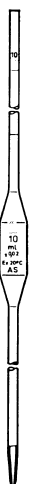

Kód	Térfogat (ml)	Hibahatár (\pm ml)	Kifolyási idő
33 535 005	0,5	0,005	
33 535 010	1	0,007	5-9
33 535 020	2	0,01	5-9
33 535 050	5	0,015	7-11
33 535 100	10	0,02	8-12
33 535 200	20	0,03	9-13
33 535 250	25	0,03	10-15
33 535 500	50	0,05	13-18
33 535 900	100	0,08	25-30

Hasas pipetta, B osztály, 1 – jelű

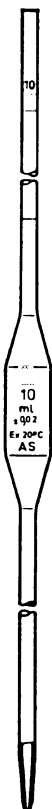

Kód	Térfogat (ml)	Hibahatár (\pm ml)
33 530 010	1	0,01
33 530 020	2	0,015
33 530 050	5	0,02
33 530 100	10	0,3
33 530 200	20	0,5
33 530 250	25	0,5
33 530 500	50	0,08
33 530 900	100	0,12

Méregpipetta, B osztályú

Kód	Térfogat (ml)	Osztás (ml)
33 575 101	1	0,01
33 575 201	2	0,01
33 575 505	5	0,05
33 575 710	10	0,1
33 575 910	25	0,1

Méregpipetta, A osztályú

Kód	Térfogat (ml)	Osztás (ml)	Hibahatár (\pm ml)
33 576 101	1	0,01	0,007
33 576 201	2	0,01	0,01
33 576 505	5	0,05	0,03
33 576 710	10	0,1	0,05
33 576 910	25	0,1	0,1
33 576 950	50	0,2	0,2

Alacsony főzőpohár, osztással, kiöntőnyílással, Boro 3.3

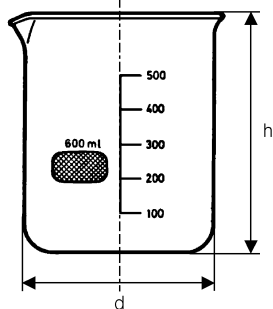

Kód	Térfogat (ml)	d \varnothing (mm)	h (mm)
B1 007 14	25	34	50
B1 007 17	50	42	60
B1 007 24	100	50	70
B1 007 29	150	60	80
B1 007 36	250	70	95
B1 007 41	400	80	110
B1 007 48	600	90	125
B1 007 53	800	100	135
B1 007 54	1000	105	145
B1 007 63	2000	132	185
B1 007 68	3000	152	210
B1 007 70	5000	170	270

Magas főzőpohár, osztással, kiöntőnyílással, Boro 3.3

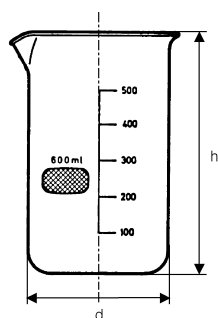

Kód	Térfogat (ml)	dØ (mm)	h (mm)
B1 002 14	25	30	55
B1 002 17	50	38	70
B1 002 24	100	48	80
B1 002 29	150	54	95
B1 002 36	250	60	120
B1 002 41	400	70	130
B1 002 48	600	80	150
B1 002 53	800	90	175
B1 002 54	1000	95	180
B1 002 63	2000	120	240
B1 002 68	3000	135	280

Alacsony főzőpohár, osztással, kiöntőnyílással, DURAN, Retrace kóddal

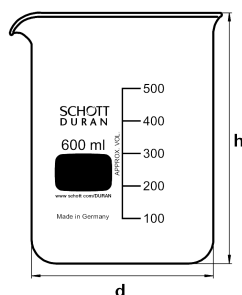

Kód	Térfogat (ml)	dØ (mm)	h (mm)
21 106 07*	5	22	30
21 106 08*	10	26	35
21 106 14	25	34	50
21 106 17	50	42	60
21 106 24	100	50	70
21 106 29	150	60	80
21 106 36	250	70	95
21 106 41	400	80	110
21 106 48	600	90	125
21 106 53	800	100	135
21 106 54	1000	105	145
21 106 63	2000	132	185
21 106 68	3000	152	210
21 106 73	5000	170	270
21 106 86*	10000	217	350

* osztás nélkül

Magas főzőpohár, osztással, kiöntőnyílással, DURAN, Retrace kóddal

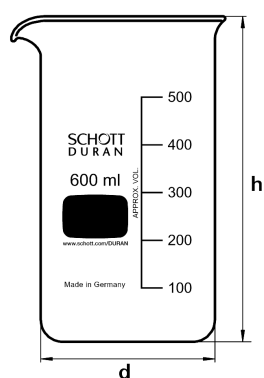

Kód	Térfogat (ml)	dØ (mm)	h (mm)
21 116 17	50	38	70
21 116 24	100	48	80
21 116 29	150	54	95
21 116 36	250	60	120
21 116 41	400	70	130
21 116 48	600	80	150
21 116 53	800	90	175
21 116 54	1000	95	180
21 116 63	2000	120	240
21 116 68	3000	135	280

Erlenmeyer lombik, szűknyakú, osztással, Boro 3.3

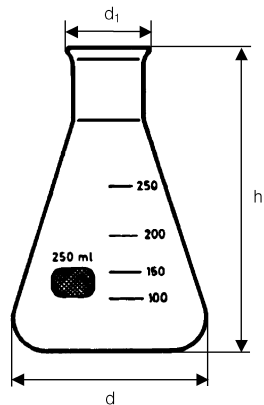

Kód	Térfogat (ml)	d ₁ Ø (mm)	dØ (mm)	h (mm)
B1 030 14	25	22	42	75
B1 030 17	50	22	51	90
B1 030 24	100	22	64	105
B1 030 29	150	28	74	118
B1 030 32	200	34	79	131
B1 030 36	250	34	85	145
B1 030 39	300	34	87	156
B1 030 44	500	34	105	180
B1 030 54	1000	42	131	220
B1 030 63	2000	50	166	280
B1 030 68	3000	52	187	310
B1 030 73	5000	52	220	365

Erlenmeyer lombik, bőnyakú, osztással, Boro 3.3

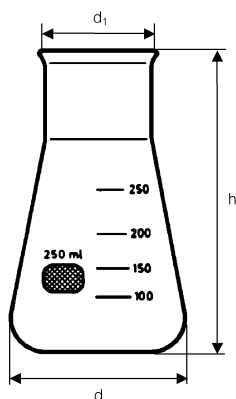

Kód	Térfogat (ml)	$d_1\varnothing$ (mm)	$d\varnothing$ (mm)	h (mm)
B1 040 14	25	31	43	70
B1 040 17	50	34	51	85
B1 040 24	100	34	64	105
B1 040 36	250	50	85	140
B1 040 38	300	50	87	156
B1 040 44	500	50	105	175
B1 040 54	1000	50	131	220
B1 040 63	2000	72	153	276

Erlenmeyer lombik, szűknyakú, osztással, DURAN, Retrace kóddal

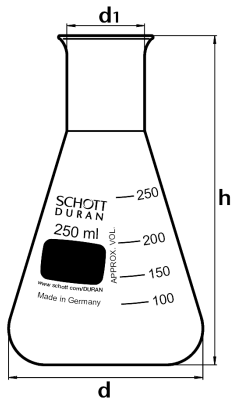

Kód	Térfogat (ml)	$d_1\varnothing$ (mm)	$d\varnothing$ (mm)	h (mm)
21 216 14	25	22	42	75
21 216 17	50	22	51	90
21 216 24	100	22	64	105
21 216 32	200	34	79	131
21 216 36	250	34	85	145
21 216 39	300	34	87	156
21 216 44	500	34	105	180
21 216 54	1000	42	131	220
21 216 63	2000	50	166	280
21 216 68	3000	51	187	310
21 216 73	5000	51	220	365

Erlenmeyer lombik, bőnyakú, osztással, DURAN, Retrace kóddal

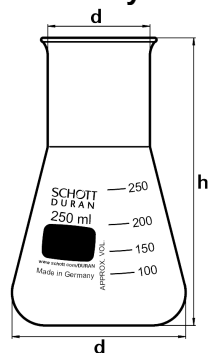

Kód	Térfogat (ml)	d _i Ø (mm)	dØ (mm)	h (mm)
21 226 14	25	31	43	70
21 226 17	50	34	51	85
21 226 24	100	34	64	105
21 226 32	200	50	79	131
21 226 36	250	50	85	140
21 226 39	300	50	87	156
21 226 44	500	50	105	175
21 226 54	1000	50	131	220
21 226 63	2000	72	153	276
21 227 68	3000	106	190	285
21 227 73	5000	108	220	322
21 227 86	10000	147	285	420

Erlenmeyer lombik normál csiszolattal

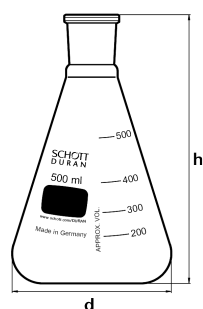

Kód	Térfogat (ml)	NS
24 193 13 H	25	14/23
24 193 20 H	50	14/23
24 193 17 H	50	19/26
24 193 18 H	50	24/29
24 193 19 H	50	29/32
24 193 24 H	100	19/26
24 193 26 H	100	24/29
24 193 27 H	100	29/32
24 193 32 H	200	29/32
24 193 36 H	250	24/29
24 193 37 H	250	29/32
24 193 38 H	250	45/40
24 193 39 H	300	29/32
24 193 44 H	500	24/29
24 193 46 H	500	29/32
24 193 47 H	500	45/40
24 193 54 H	1000	24/29
24 193 56 H	1000	29/32
24 193 57 H	1000	45/40

Erlenmeyer lombik csavaros kupakkal, autoklávozható

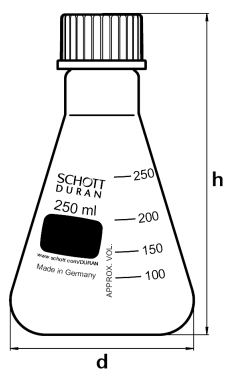

Kód	Térfogat (ml)	GL
20 015 24 H	100	32
20 015 36 H	250	32
20 015 44 H	500	32
20 015 54 H	1000	32

* más méretben is megrendelhető

Szívópalack Erlenmeyer forma, üveg olivával

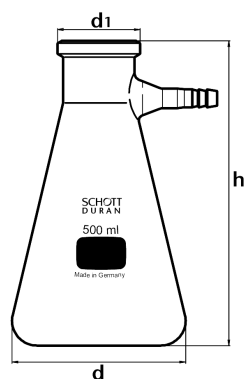

Kód DURAN	Kód Boro 3.3	Térfogat (ml)	d ₁ ∅ (mm)	d∅ (mm)	h (mm)
21 201 24	21 200 24 H	100	24	64	105
21 201 36	21 200 36 H	250	34	85	155
21 201 44	21 200 44 H	500	34	105	185
21 201 54	21 200 54 H	1000	45	135	230
21 201 63	21 200 63 H	2000	60	166	255

Jódszámláló lombik üveg dugóval

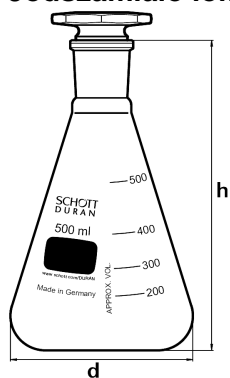

Kód	Térfogat (ml)	NS
24 192 14 H	25	29/32
24 192 17 H	50	29/32
24 192 27 H	100	29/32
24 192 32 H	200	29/32
24 192 37 H	250	29/32
24 192 39 H	300	29/32
24 192 46 H	500	29/32
24 192 54 H	1000	29/32

Gömb lombik, szűknyakú, Boro 3.3

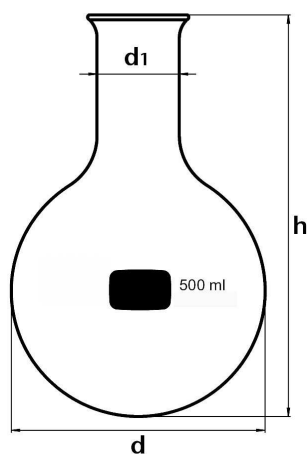

Kód	Térfogat (ml)	d ₁ (mm)	d (mm)	h (mm)
B1 050 17	50	22	51	105
B1 050 24	100	22	64	115
B1 050 36	250	34	85	145
B1 050 44	500	34	105	175
B1 050 54	1000	42	131	210
B1 050 64	2000	50	166	260
B1 050 71	4000	50	207	315
B1 050 77	6000	65	236	355
B1 050 86	10000	65	279	420

Gömblobbik, szűknyakú, DURAN

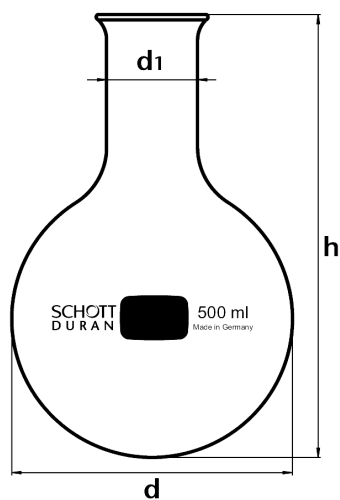

Kód	Térfogat (ml)	d ₁ (mm)	d (mm)	h (mm)
21 721 17	50	26	51	95
21 721 24	100	26	64	110
21 721 36	250	34	85	144
21 721 44	500	34	105	168
21 721 54	1000	42	131	200
21 721 64	2000	42	166	260
21 721 68	3000	50	185	260
21 721 71	4000	50	207	290
21 721 73	5000	50	223	305
21 721 77	6000	51	236	330
21 721 86	10000	65	279	380
21 721 91	20000	76	345	515

Gömblobbik, bőnyakú, DURAN

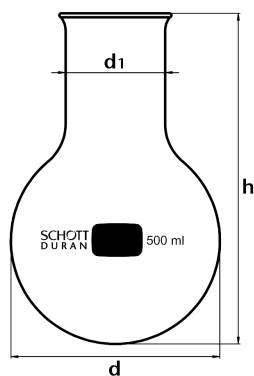

Kód	Térfogat (ml)	d ₁ (mm)	d (mm)	h (mm)
21 741 17	50	34	51	105
21 741 24	100	35	64	110
21 741 36	250	51	85	145
21 741 44	500	50	105	168
21 741 54	1000	50	131	210
21 741 64	2000	50	166	240
21 741 68	3000	65	185	260
21 741 71	4000	76	206	315

21 741 73	5000	65	223	310
21 741 77	6000	65	236	330
21 741 86	10000	89	279	420
21 741 91	20000	89	345	520

Gömblobbik normál csiszolattal

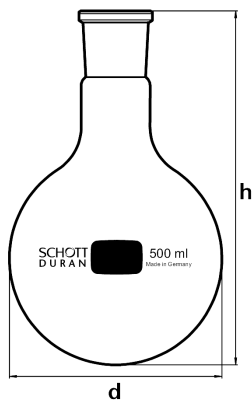

Kód	Térfogat (ml)	NS
24 170 13 B	25	14/23
24 170 14	25	19/26
24 170 20 B	50	14/23
24 170 17	50	19/26
24 170 18	50	24/29
24 170 19 B	50	29/32
24 170 25	100	14/23
24 170 24	100	19/26
24 170 26	100	24/29
24 170 27	100	29/32
24 170 36	250	24/29
24 170 37	250	29/32
24 170 38	250	45/40
24 170 44	500	24/29
24 170 46	500	29/32
24 170 47	500	45/40
24 170 54	1000	24/29
24 170 56	1000	29/32
24 170 57	1000	45/40
24 170 63	2000	29/32
24 170 64	2000	45/40
24 170 71	4000	29/32
24 170 72	4000	45/40

Gömblobbik két nyakkal, normál csiszolattal

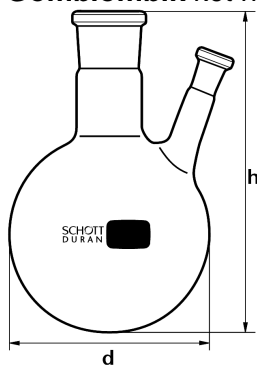

Kód	Térfogat (ml)	Középső nyak NS	Szélső nyak NS
24 183 26 H	100	24/29	14/23
24 183 27 H	100	29/32	14/23
24 183 36 H	250	24/29	14/23
24 183 37 H	250	29/32	14/23
24 183 44 H	500	24/29	14/23
24 183 46 H	500	29/32	14/23
24 183 54 H	1000	24/29	14/23
24 183 56 H	1000	29/32	14/23
24 183 63 H	2000	29/32	14/23

Gömblobbik három nyakkal, normál csiszolattal

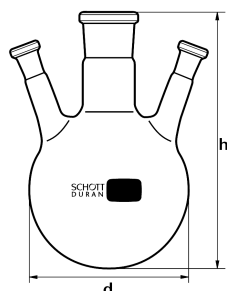

Kód	Térfogat (ml)	Középső nyak NS	Szélső nyak NS
24 188 27 H	100	29/32	14/23
24 188 36 H	250	24/29	14/23
24 188 37 H	250	29/32	14/23
24 188 43 H	500	24/29	14/23
24 188 46 H	500	29/32	14/23
24 188 53 H	1000	24/29	14/23
24 188 55 H	1000	29/32	14/23

Gömblobbik három egyenes nyakkal, normál csiszolattal

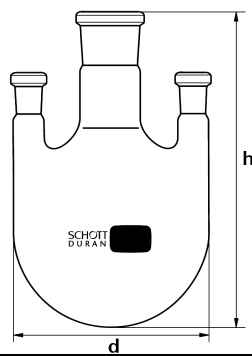

Kód	Térfogat (ml)	Középső nyak NS	Szélső nyak NS
24 185 36 H	250	24/29	19/26
24 185 37 H	250	29/32	14/23
24 185 44 H	500	24/29	19/26
24 185 46 H	500	29/32	14/23
24 185 45 H	500	29/32	29/32
24 185 54 H	1000	24/29	19/26
24 185 56 H	1000	29/32	14/23
24 185 55 H	1000	29/32	29/32
24 185 63 H	2000	29/32	14/23
24 185 65 H	2000	29/32	29/32

Állólombik, szűknyakú, Boro 3.3

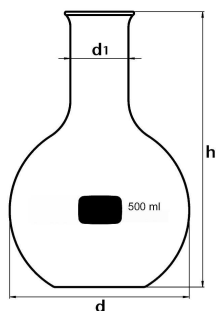

Kód	Térfogat (ml)	d ₁ (mm)	d (mm)	h (mm)
B1 055 17	50	22	51	105
B1 055 24	100	22	64	110
B1 055 36	250	34	85	140
B1 055 44	500	34	105	170
B1 055 54	1000	42	131	200
B1 055 64	2000	50	166	250
B1 055 71	4000	50	207	300
B1 055 77	6000	65	236	340
B1 055 86	10000	65	279	400

Állólombik, bőnyakú, Boro 3.3

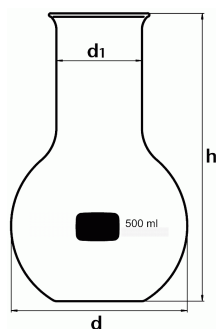

Kód	Térfogat (ml)	d ₁ (mm)	d (mm)	h (mm)
B1 056 17	50	34	51	100
B1 056 24	100	34	64	110
B1 056 36	250	50	85	140
B1 056 44	500	50	105	170
B1 056 54	1000	50	131	200
B1 056 64	2000	76	166	250

Állólombik, szűknyakú, DURAN

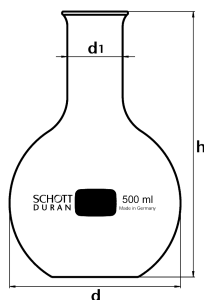

Kód	Térfogat (ml)	d ₁ (mm)	d (mm)	h (mm)
21 711 17	50	26	51	90
21 711 24	100	26	64	105
21 711 36	250	34	85	138
21 711 44	500	34	105	163
21 711 54	1000	42	131	190
21 711 64	2000	42	166	230
21 711 68	3000	50	185	250
21 711 71	4000	50	207	275
21 711 73	5000	50	223	290
21 711 77	6000	65	237	315
21 711 86	10000	65	280	360

Állólombik, bőnyakú, DURAN

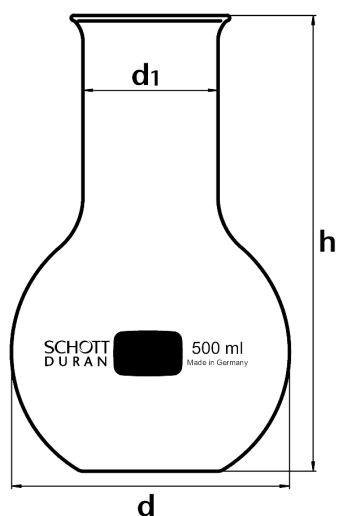

Kód	Térfogat (ml)	d ₁ (mm)	d (mm)	h (mm)
21 731 17	50	35	51	100
21 731 24	100	34	64	110
21 731 36	250	50	85	140
21 731 44	500	50	103	170
21 731 54	1000	50	131	200
21 731 64	2000	50	166	230

Állólombik normál csiszolattal

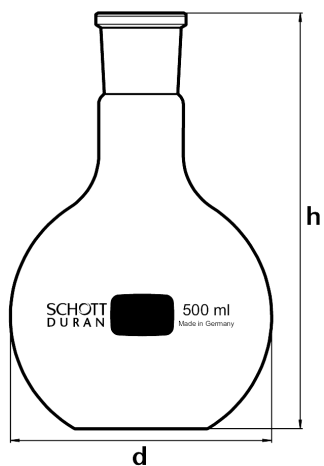

Kód	Térfogat (ml)	NS
24 171 19 H	50	29/32
24 171 24 H	100	19/26
24 171 26 H	100	24/29
24 171 27 H	100	29/32
24 171 36 H	250	24/29
24 171 37 H	250	29/32
24 171 44 H	500	24/29
24 171 46 H	500	29/32
24 171 54 H	1000	24/29
24 171 56 H	1000	29/32
24 171 63 H	2000	29/32

Üvegtölcsér

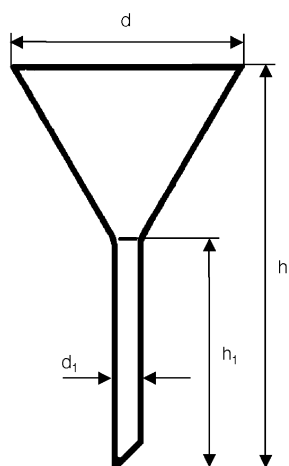

Kód	d (mm)	h (mm)	d ₁ (mm)
21 351 28	45	80	6
21 351 33	55	95	8
21 351 38	70	120	8
21 351 41	80	140	10
21 351 46	100	180	10
21 351 51	120	210	16
21 351 57	150	250	16
21 351 61	200	325	26
21 351 66	250	360	30
21 351 69	300	409	30

Analitikai tölcser

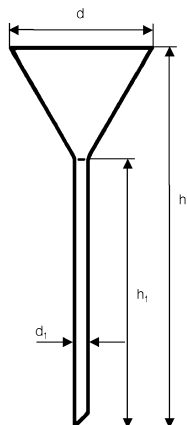

Kód	d (mm)
21 353 02	45
21 353 04	55
21 353 06	70
21 353 07	80

Portölcsér

Kód	d (mm)
21 354 330	55
21 354 380	70
21 354 410	80
21 354 461	100
21 354 510	120

Bordás tölcser

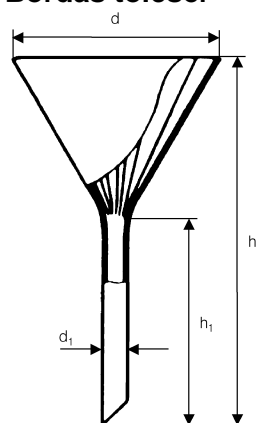

Kód	d (mm)
21 352 02	45
21 352 04	55
21 352 06	70
21 352 07	80
21 352 08	100

Választótölcsér kúpos, tefloncsappal *, műanyag dugóval

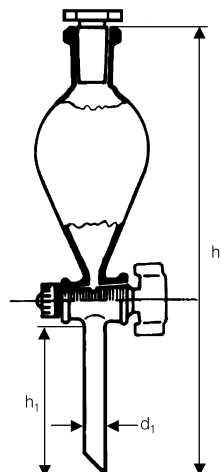

Kód	Térfogat (ml)	Csap NS	Dugó NS
24 294 17 H	50	2,5	19/26
24 294 24 H	100	2,5	19/26
24 294 36 H	250	4	29/32
24 294 44 H	500	4	29/32
24 294 54 H	1000	6	29/32
24 294 63 H	1000	6	29/32

* üvegcsappal is megrendelhető

Csepegtető tölcser, üvegcsappal, osztással

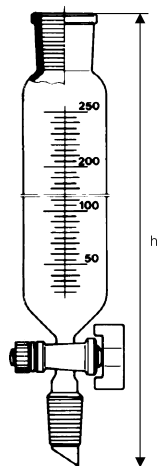

Kód	Térfogat (ml)	Dugó és Tok NS	h (mm)	Csap NS
24 124 19	50	14/23	230	3
24 124 24	100	19/26	250	3
24 124 37	250	29/32	340	4
24 124 46	500	29/32	405	4
24 124 56	1000	29/32	480	6

Csepegtető tölcser, nyomáskiegyenlítő csővel üvegcsappal, osztással

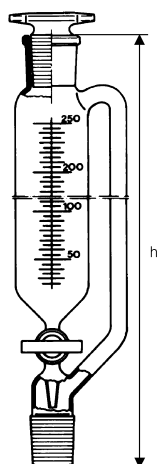

Kód	Térfogat (ml)	Dugó és Tok NS	h (mm)	Csap NS
24 125 19	50	14/23	240	3
24 125 24	100	19/26	270	3
24 125 37	250	29/32	380	4
24 125 46	500	29/32	430	4

Szűrőtégely



Kód	Porozitás	Térfogat (ml)	d (mm)
25 851 0x	2-4	8	24
25 851 1x	1-4	15	28
25 851 2x	1-5	30	36
25 851 3x	1-5	50	46

Szűrőnucss

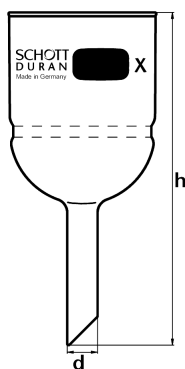

Kód	Porozitás	Térfogat (ml)	Szűrőlap Ø (mm)
25 852 0x	1-5	50	35
25 852 1x	1-5	75	45
25 852 2x	1-5	125	60
25 852 3x	1-5	500	95
25 852 4x	1-5	1000	120
25 852 6x	1-4	4000	175

Laboratóriumi üveg, DIN menettel, autoklávozható, kiöntőgyűrűvel és kupakkal, Boro 3.3

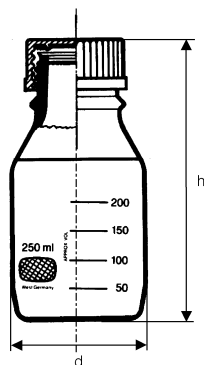

Kód	Kód barna	Térfogat (ml)	DIN menet (GL)	d (mm)	h (mm)
B1 010 24	B1 011 24	100	45	56	105
B1 010 36	B1 011 36	250	45	70	143
B1 010 44	B1 011 44	500	45	86	181
B1 010 54	B1 011 54	1000	45	101	230
B1 010 63	B1 011 63	2000	45	136	265
B1 010 73	B1 011 73	5000	45	186	355
B1 010 86	B1 011 86	10000	45	234	435
B1 010 91	B1 011 91	20000	45		

DURAN® laboratóriumi üveg, DIN menettel, autoklávozható, kiöntőgyűrűvel és **kék kupakkal**

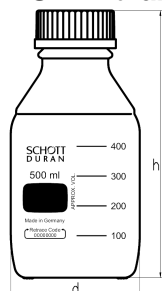

Kód	Térfogat (ml)	DIN menet (GL)	d (mm)	h (mm)
21 801 145*	25	25	36	74
21 801 175	50	32	46	91
21 801 245	100	45	56	105
21 801 365	250	45	70	143
21 801 445	500	45	86	181
21 801 545	1000	45	101	230
21 801 635	2000	45	136	265
21 801 735	5000	45	182	335
21 801 865	10000	45	227	415
21 801 885	15000	45	268	450
21 801 915	20000	45	288	510

* speciálisan kiképzett üveg kiöntőrész, így a kiöntőgyűrű elhagyható

DURAN® laboratóriumi üveg, DIN menettel, autoklávozható, (kupak és kiöntőgyűrű nélkül)

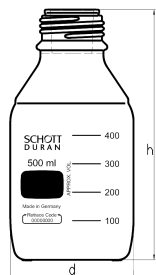

Kód	Kód barna	Térfogat (ml)	DIN menet (GL)	d (mm)	h (mm)
21 801 14	21 806 14	25	25	36	70
21 801 17	21 806 17	50	32	46	87
21 801 24	21 806 24	100	45	56	100
21 801 36	21 806 36	250	45	70	138
21 801 44	21 806 44	500	45	86	176
21 801 54	21 806 54	1000	45	101	225
21 801 63	21 806 63	2000	45	136	260
21 801 73	21 806 73	5000	45	182	330
21 801 86	21 806 86	10000	45	227	410
21 801 88	21 806 88	15000	45	268	445
21 801 91	21 806 91	20000	45	288	505

DURAN® négyszögletes laboratóriumi üveg, DIN menettel, [kék](#) kupakkal és kiöntőgyűrűvel, autoklávozható

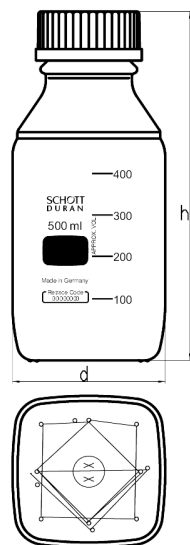

Kód	Térfogat (ml)	DIN menet (GL)	d (mm)	h (mm)
21 820 245	100	32	50	109
21 820 365	250	45	64	143
21 820 445	500	45	78	181
21 820 545	1000	45	94	222

DURAN® laboratóriumi üveg, GLS 80, autoklávozható, kiöntőgyűrűvel és kék kupakkal

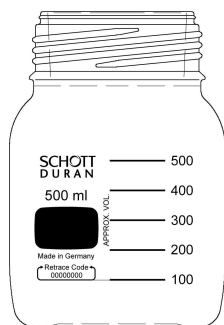

Kód	Térfogat (ml)	DIN menet (GL)	d (mm)	h (mm)
211 126 27	500	80	101	148
211 127 13	1000	80	101	218
211 127 15	2000	80	136	248
211 139 49	5000	80	182	311
211 139 50	10000	80	227	395
211 139 51	20000	80	288	483

Menetes zárókupak PP, 140 °C-ig autoklávozható vízgőzzel

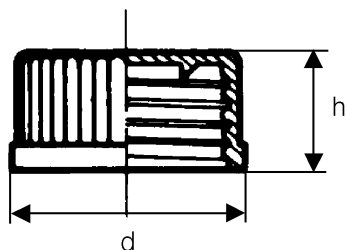

Kód	GL	d (mm)	h (mm)	szín
29 239 13	25	33	19	kék
29 239 19	32	40	24	kék
29 239 28	45	54	26	kék
29 338 280	45	54	26	sárga
29 338 286	45	54	26	zöld
29 338 288	45	54	26	szürke

Kiöntőgyűrű PP, kék, 140 °C-ig autoklávozható vízgőzzel

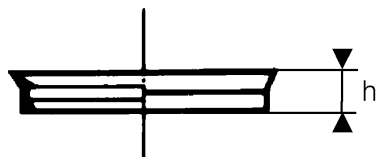

Kód	GL	h (mm)
29 242 19	32	4
29 242 28	45	4

Menetes zárókupak PBT, piros, PTFE bevonatos tömítéssel, 180 °C-ig hőlégmenterizálható

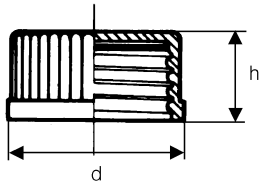

Kód	GL	d (mm)	h (mm)
29 240 08	14		
29 240 11	18		
29 240 13	25	33	23
29 240 19	32	41	26
29 240 28	45	54	28

Kiöntőgyűrű ETFE, piros, 180 °C-ig hőlégmenterizálható

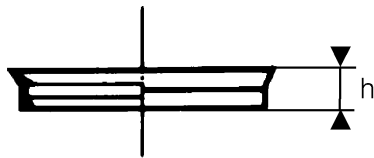

Kód	GL	h (mm)
29 244 19	32	4
29 244 28	45	4

Szilikon tömítés PTFE bevonattal, a PBT kupakokhoz, 180 °C-ig hőálló

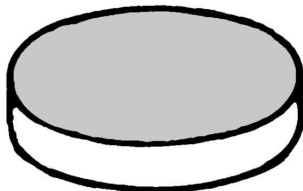

Kód	GL
29 248 08	14
29 248 11	18
29 248 13	25
29 248 19	32
29 248 28	45

Menetes zárókupak PBT, piros, lyukkal

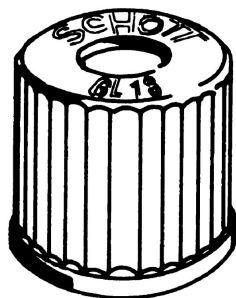

Kód	GL
29 227 05	14
29 227 06	18
29 227 09	25
29 227 08	32
29 227 10	45

Szilikon tömítés, vulkanizált PTFE bevonattal, lyukas

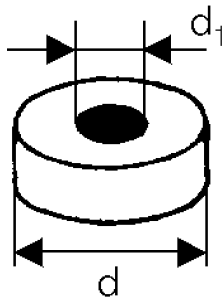

Kód	GL	d x d1 (mm)	Cső átm (mm)
29 234 04	14	12 x 6	5,5-6,5
29 235 06	18	16 x 6	5,5-6,5
29 235 08	18	16 x 8	7,5-9,0
29 235 10	18	16 x 10	9,0-11,0
29 237 08	25	22 x 8	7,5-9,0
29 237 10	25	22 x 10	9,0-11,0
29 237 12	25	22 x 12	11,0-13,0
29 236 10	32	29 x 10	9,0-11,0
29 236 12	32	29 x 12	11,0-13,0
29 236 14	32	29 x 14	13,0-15,0
29 236 16	32	29 x 16	15,0-17,0
29 236 18	32	29 x 18	17,0-19,0
29 238 26	45	42 x 26	25,0-27,0
29 238 32	45	42 x 32	31,0-33,0

Menetes zárókupak PP eredetiség zárral, 140 °C-ig autoklávozható vízgőzzel

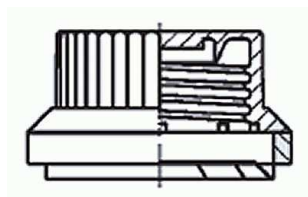

Kód	GL	d (mm)	h (mm)	szín
210 175 26	45	54	26	kék

Prémium zárókupak, TPCh260, -196 °C - +260 °C hőmérsékleti tartomány

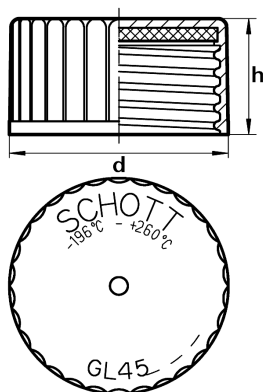

Kód	GL	
2M 108 8679	45	Kiöntőnyűű
2M 108 8678	45	Kiöntőnyűű

Membrán zárókupak, PP, közepén 0,2 µm-es PTFE membrán, 140 °C-ig autoklávozzható, extrém gyors nyomáskiegyenlítés 0,1 bar-tól

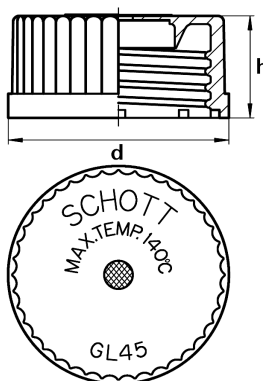

Kód	GL
2M 108 8655	45

PP : polipropilén

PBT : polibutiléntereftalát

PTFE : politetrafluoretilén (teflon)

ETFE : etilén - tetrafluoretilén kopolimer

Folyadéküveg, normálcsiszolatos dugóval

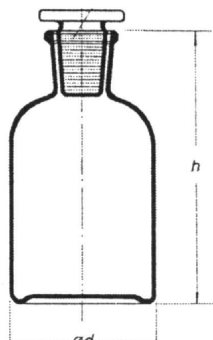

Kód fehér	Kód barna	Térfogat (ml)	Átm x mag d x h (ml)	NS
27 010 17	27 011 17	50	41,5 x 77	14/15
27 010 24	27 011 24	100	51,5 x 103	14/23
27 010 36	27 011 36	250	69 x 131	19/26
27 010 44	27 011 44	500	85 x 163	24/29
27 010 54	27 011 54	1000	106,5 x 199	29/32
27 010 63	27 011 63	2000	132 x 245	29/32
27 010 73	27 011 73	5000	181 x 325	45/40
27 010 86	27 011 86	10000	227 x 403	60/46

Porüveg, normálcsiszoltos dugóval

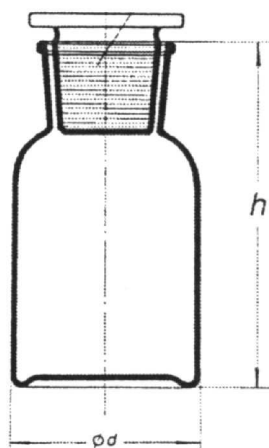

Kód fehér	Kód barna	Térfogat (ml)	Átm x mag d x h (ml)	NS
27 012 17	27 013 17	50	41,5 x 76	24/20
27 012 24	27 013 24	100	51,5 x 95	29/22
27 012 36	27 013 36	250	69 x 128	34/24
27 012 44	27 013 44	500	85 x 162	45/27
27 012 54	27 013 54	1000	106,5 x 187	60/31
27 012 63	27 013 63	2000	132 x 238	60/31
27 012 73		5000	181 x 338	85/55
27 012 86		10000	227 x 227	85/55

Ételmintás üveg

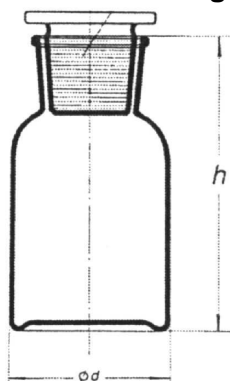

Kód	Térfogat (ml)
27 012 24	100
27 012 36	250

Porüveg, szögletes

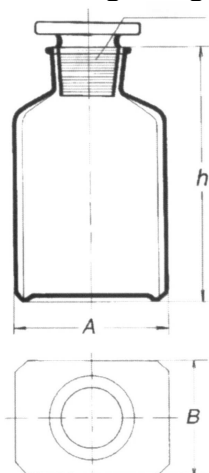

Kód fehér	Kód barna	Térfogat (ml)	A x B (mm)	h (mm)	NS
27 014 100	27 015 100	100	51 x 51	103	29/22
27 014 150	27 015 150	150	70,5 x 51,5	103	29/22
27 014 250	27 015 250	250	70 x 50	143	29/22
27 014 350	27 015 350	350	71,5 x 71,5	153	34/24
27 014 500	27 015 500	500	92 x 71,5	148	34/24
27 014 750	27 015 750	750	90 x 71,5	237	45/27

Winkler palack

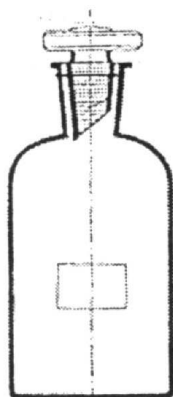

Kód	Térfogat (ml)	NS
27 020 01	100-150	14/23
27 020 02	250-300	19/26

Kémcső

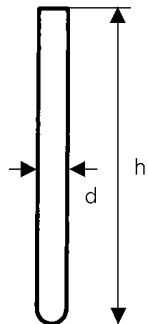

Kód	d (mm)	h (mm)	
26 370 01 H	10	100	
26 371 00 H	11	70	
26 371 03	12	100	
26 370 03 H	12	105	
26 371 02	16	100	
26 370 06 H	16	105	
26 375 01	16	150	
26 370 07	16	160	
26 370 08 H	16	160	peremes
26 370 09 H	18	180	
26 370 10	18	180	peremes

Szemcseppentő

Kód	d (mm)	h (mm)
26 372 00 H	6	70

Centrifugacső gömbölyű véggel

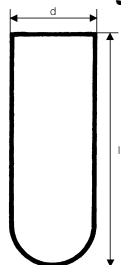

Kód	Névl. Térfogat (ml)	d x h (mm)
21 600 01 H	10	16 x 100
21 600 03 H	20	22 x 100
21 600 04 H	25	24 x 100

Keverő üvegbot

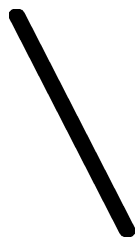

Kód	d (mm)	h (mm)
26 703 01 H	6	150
26 703 02 H	6	200
26 703 03 H	6	250

Keverő üvegbot, Duran üvegből

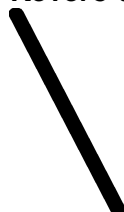

Kód	d (mm)	h (mm)
26 704 01 H	8	250
26 704 02 H	8	300
26 704 03 H	8	400
26 704 04 H	8	500

Borszeszégő

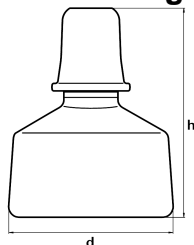

Kód	Térfogat (ml)	Megjegyzés
23 401 00	100	Kanóc és kanóctartó nélkül
29 402 00		Kanóc
29 403 00		Kanóctartó (alumínium)

Lepárló csésze

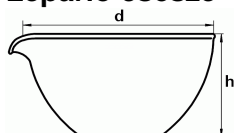

Kód	Térfogat (ml)	d (mm)	h (mm)
21 301 24	10	40	18
21 301 32	15	50	25
21 301 34	45	60	30
21 301 38	60	70	35
21 301 41	90	80	45
21 301 44	170	95	55
21 301 49	320	115	65
21 301 54	600	140	80
21 301 59	1500	190	100
21 301 63	2500	230	130

Kristályosító csésze

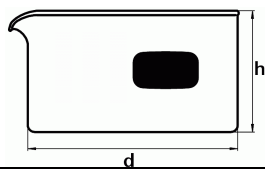

Kód	Térfogat (ml)	d (mm)	h (mm)
21 311 24	20	40	25
21 311 32	40	50	30
21 311 34	60	60	35
21 311 38	100	70	40
21 311 41	150	80	45
21 311 44	300	95	55
21 311 49	500	115	65
21 311 54	900	140	75
21 311 59	2000	190	90
21 311 63	3500	230	100

Petricésze (nem hőálló)

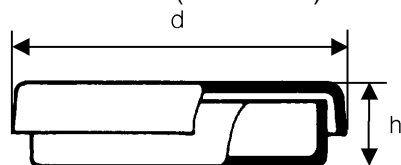

Kód	d (mm)	h (mm)
23 755 39	40	12
23 755 40	60	15
23 755 42	80	15
23 755 45	90	15
23 755 48	100	20
23 755 51	120	20
23 755 52	150	25
23 755 56	180	30
23 755 59	200	30

Petricésze (hőálló)

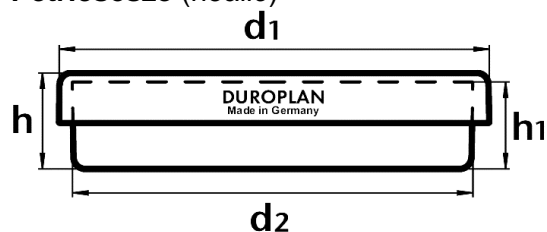

Kód	d ₁ x h ₁ (mm)	d ₂ (mm)	h (mm)
21 755 41	60 x 20	54,5	22
21 755 43	80 x 20	74	22
21 755 46	100 x 15	94	17
21 755 48	100 x 20	94	22
21 755 51	120 x 20	114	22
21 755 53	150 x 30	143	32

Indikátor üveg

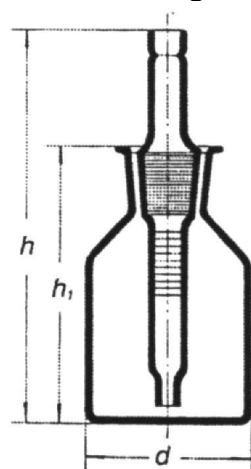

Kód	Kód barna	Térf. (ml)	d (mm)	h (mm)	h ₁ (mm)
27 021 17	27 022 17	50	42	107	77
27 021 24	27 022 24	100	52	133	103
27 021 36	27 022 36	250	70	161	131

Üvegdoboz ráeső fedővel

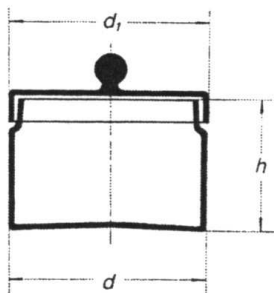

Kód	d (mm)	h (mm)
27 001 01	80	80
27 001 02	100	100
27 001 03	120	120
27 001 04	150	150
27 001 05	200	150
27 001 06	200	200

Üvegyöngy

Kód	d (mm)
29 901 02	2
29 901 03	3
29 901 04	4
29 901 05	5
29 901 06	6
29 901 07	7
29 901 08	8
29 901 09	9
29 901 10	10

Liebig hűtő, 2 NS és 2 oliva

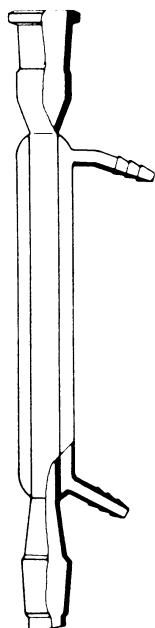

Kód	NS dugó, hüvely NS	Köpenyhossz (mm)
24 251 11 H	14/23	160
24 251 21 H	14/23	250
24 251 23 H	24/29	250
24 251 24 H	29/32	250
24 251 43 H	24/29	400
24 251 44 H	29/32	400

Golyós hűtő, 2 NS és 2 oliva

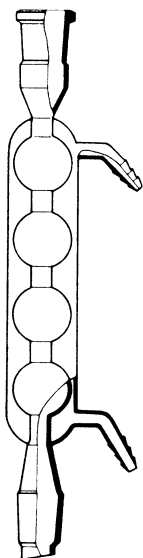

Kód	NS dugó, hüvely NS	Köpenyhossz (mm)
24 252 11 H	14/23	160
24 252 21 H	14/23	250
24 252 23 H	24/29	250
24 252 24 H	29/32	250
24 252 43 H	24/29	400
24 252 44 H	29/32	400

Spirál hűtő, 2 NS és 2 oliva

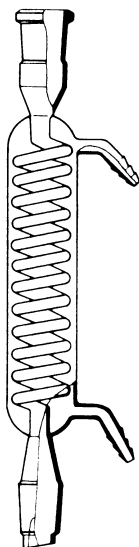

Kód	NS dugó, hüvely NS	Köpenyhossz (mm)
24 251 243	14/23	160
24 251 253	29/32	250
24 251 263	29/32	400

Dimroth hűtő, 2 NS és 2 oliva

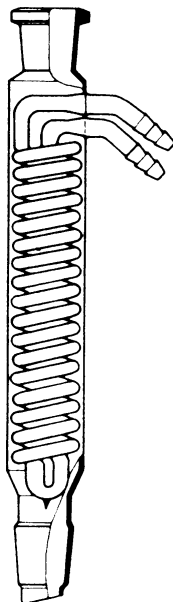

Kód	NS dugó, hüvely NS	Köpenyhossz (mm)
24 254 11 H	14/23	160
24 254 23 H	24/29	250
24 254 24 H	29/32	250
24 254 44 H	29/32	400

Intenzív (duplafalú spirál) hűtő, 2 NS és 2 oliva

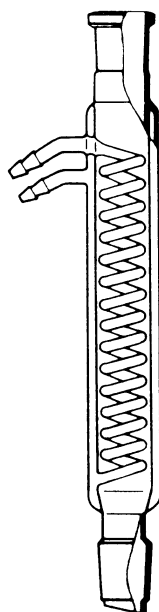

Kód	NS dugó, hüvely NS	Köpenyhossz (mm)
24 255 11 H	14/23	160
24 255 23 H	24/29	250
24 255 24 H	29/32	250
24 255 43 H	24/29	400
24 255 44 H	29/32	400

Golyós hűtő, (Extraktorhoz)

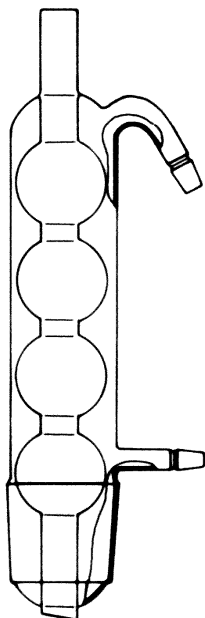

Kód	dugó NS	Extraktor (ml)
24 271 41 H	29/32	30
24 271 52 H	34/35	70
24 271 63 H	45/40	100-250

Dimroth hűtő, (Extraktorhoz)

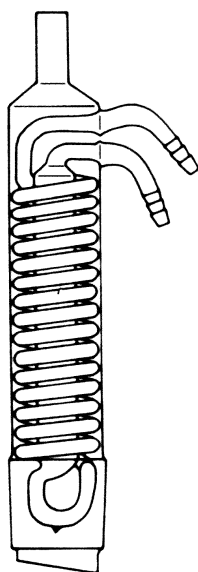

Kód	dugó NS	Extraktor (ml)
24 270 41 H	29/32	30
24 270 52 H	34/35	70
24 270 63 H	45/40	100-250

Soxhlet extraktor középső rész

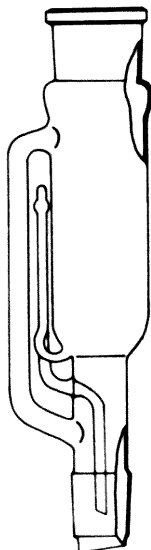

Kód	hűtő csiszolat NS	Extraktor (ml)
24 272 41 H	29/32	30
24 272 52 H	34/35	70
24 272 63 H	45/40	100
24 272 64 H	45/40	150
24 272 65 H	45/40	200
24 272 66 H	45/40	250

Soxhlet extrakciós készülék (hűtő, középrész, lombik)

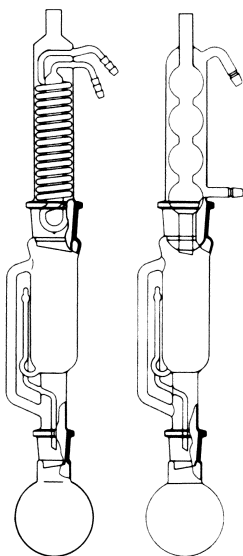

Kód Dimroth	Kód Allihn	extr. térfogat (ml)	Hűtő NS	Lombik (ml)
24 273 01 H	24 274 01 H	30	29/32	100
24 273 02 H	24 274 02 H	70	34/35	100
24 273 03 H	24 274 03 H	100	45/40	250
24 273 04 H	24 274 04 H	150	45/40	250
24 273 05 H	24 274 05 H	200	45/40	250
24 273 06 H	24 274 06 H	250	45/40	500

Y feltét, párhuzamos nyakkal

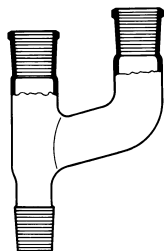

Kód	NS dugó	NS hüvely
24 224 03 H	24/29	24/29
24 224 04 H	29/32	29/32

Összekötő 75°, 2 NS dugó

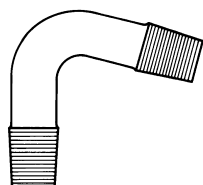

Kód	NS dugó
24 221 01 H	14/23
24 221 02 H	19/26
24 221 03 H	24/29
24 221 04 H	29/32

Összekötő 90°, 2 NS dugó

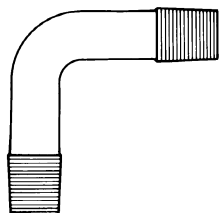

Kód	NS dugó
24 303 01 H	14/23
24 303 02 H	19/26
24 303 03 H	24/29
24 303 04 H	29/32

Claisen-feltét

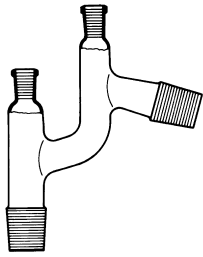

Kód	Hüvely NS	Függőleges dugó NS	Oldalsó dugó NS
24 223 22 H	14/23	19/26	19/26
24 223 33 H	14/23	24/29	24/29
24 223 44 H	14/23	29/32	29/32

Szárítócső , hajlított, normálcsiszolat dugóval

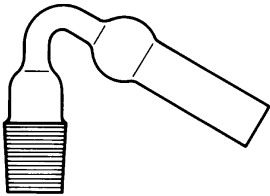

Kód	NS
24 262 01 H	14/23
24 262 02 H	19/26
24 262 03 H	24/29
24 262 04 H	29/32

Összekötő , normálcsiszolat dugóval, hajlított olivával

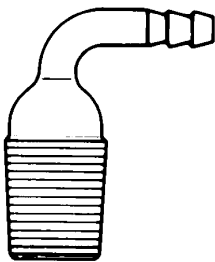

Kód	NS
24 300 01 H	14/23
24 300 02 H	19/26
24 300 03 H	24/29
24 300 04 H	29/32

Desztilláló előtét, hajlított, normálciszolat hüvellyel

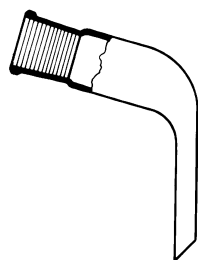

Kód	NS
24 310 01 H	14/23
24 310 02 H	19/26
24 310 03 H	24/29
24 310 04 H	29/32

Vakuum elszívó, hajlított, 2 NS, olivával

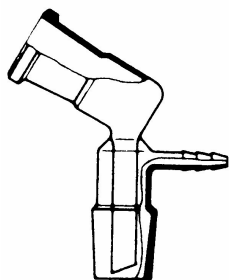

Kód	dugó és hüvely NS
24 130 01 H	14/23
24 130 03 H	24/29
24 130 04 H	29/32

Vakuum elszívó, egyenes, 2 NS, olivával

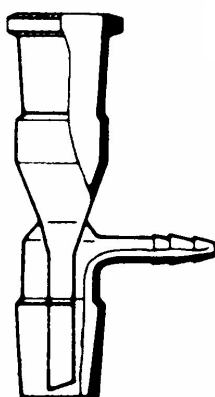

Kód	dugó és hüvely NS
24 131 01 H	14/23
24 131 03 H	24/29
24 131 04 H	29/32

Habzástgátló, egyenes, NS dugóval és hüvellyel



Kód	dugó és hüvely NS
24 350 01 H	14/23
24 350 03 H	24/29
24 350 04 H	29/32

Habzástgátló, hajlított, 2 NS dugóval

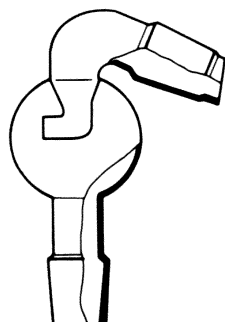

Kód	dugó NS
24 351 01 H	14/23
24 351 12 H	19/26
24 351 03 H	24/29
24 351 04 H	29/32

Desztilláló híd, NS 14/23 tokkal, 2 párhuzamos dugóval

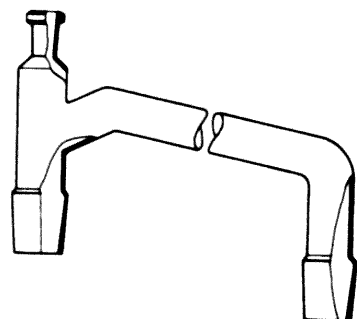

Kód	Dugó NS	Köpenyhossz (mm)
24 352 11 H	14/23	150
24 352 22 H	19/26	200
24 352 33 H	24/29	300
24 352 44 H	29/32	350

Desztilláló híd Liebig hűtővel, NS 14/23 tokkal, 2 dugóval

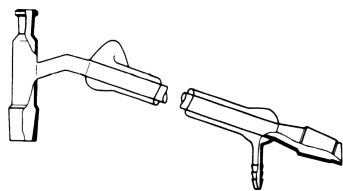

Kód	Dugó NS	Köpenyhossz (mm)
24 353 11 H	14/23	160
24 353 12 H	14/23	250
24 353 42 H	29/32	250
24 353 44 H	29/32	400

Átmenet, normálcsiszolattal

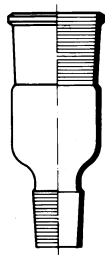
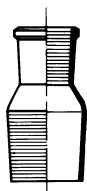

Kód	Hüvely NS	Dugó NS
24 114 12 H	14/23	19/26
24 114 13 H	14/23	24/29
24 114 14 H	14/23	29/32
24 114 21 H	19/26	14/23
24 114 23 H	19/26	24/29
24 114 24 H	19/26	29/32
24 114 31 H	24/29	14/23
24 114 32 H	24/29	19/26
24 114 34 H	24/29	29/32
24 114 41 H	29/32	14/23
24 114 42 H	29/32	19/26
24 114 43 H	29/32	24/29

Menetes üvegcső NS dugóval

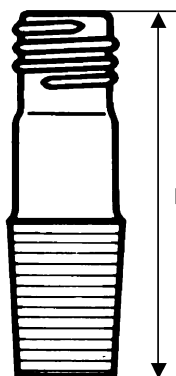

Kód	Menet GL	Dugó NS
24 840 11 H	14	14/23
24 840 12 H	14	19/26
24 840 13 H	14	24/29
24 840 14 H	14	29/32
24 840 21 H	18	14/23
24 840 22 H	18	19/26
24 840 23 H	18	24/29
24 840 24 H	18	29/32
24 840 32 H	25	19/26
24 840 33 H	25	24/29
24 840 34 H	25	29/32
24 840 43 H	32	24/29
24 840 44 H	32	29/32

Normálcsiszolát hüvely



Kód	NS	Átmérő Ø (mm)	Falvast. (mm)
28 651 80	10/19	13	1,5
28 652 10	12/21	15	1,8
28 653 28	14/23	17	1,8
28 654 12	19/26	22	1,8
28 654 60	24/29	28	2,0
28 655 82	29/32	33	2,0
28 655 93	34/35	38	2,0
28 656 63	45/40	50	2,5

Normálciszolat dugó



Kód	NS	Átmérő Ø (mm)	Falvast. (mm)
28 615 18	10/19	8	1,5
28 615 25	12/21	11	1,5
28 615 42	14/23	13	1,5
28 615 54	19/26	17	1,8
28 615 63	24/29	22	1,8
28 615 88	29/32	26	2,0
28 615 95	34/35	30	2,0
28 616 23	45/40	40	2,3

Normálciszolat dugó, kifolyóval



Kód	NS	Átmérő Ø (mm)	Falvast. (mm)
28 616 34	10/19	8	1,5
28 616 40	12/21	11	1,5
28 616 43	14/23	13	1,5
28 616 53	19/26	17	1,8
28 616 61	24/29	22	1,8
28 616 80	29/32	26	2,0
28 616 86	34/35	30	2,0
28 616 94	45/40	40	2,3

Menetes üvegcső

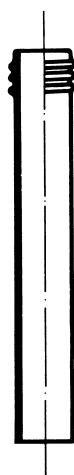

Kód	GL	Átmérő Ø (mm)	Falvast. (mm)
28 625 16	14	12	1,5
28 625 32	18	16	1,8
28 625 62	25	22	1,8
28 625 88	32	28	2,0
28 606 34	45	40	2,3

Csap, egyenes, áteresztő

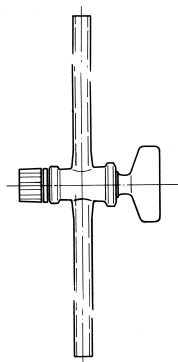

Kód	NS	Furat (mm)
28 640 34	12,5	1,5
28 640 36	12,5	2,5
28 640 48	14,5	2,5
28 640 54	14,5	4
28 640 68	18,8	4
28 640 72	18,8	6

Teflonszelep

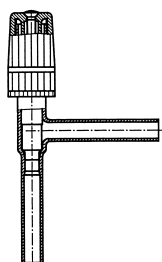

Kód	Furat (mm)
24 194 01 H	0-6
24 194 02 H	6-10

Záródugó, üveg

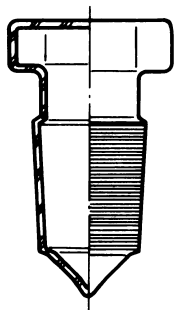

Kód	NS
28 611 42	10/19
28 611 48	12/21
28 611 54	14/23
28 611 60	19/26
28 611 66	24/29
28 611 74	29/32
28 611 79	34/35
28 611 81	45/40

Záródugó, PE műanyag

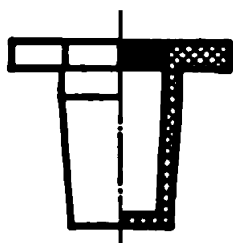

Kód	NS
29 204 03	10/19
29 204 04	12/21
29 204 06	14/23
29 204 07	19/26
29 204 08	24/29
29 204 09	29/32
29 204 12	45/40

Csiszolat bilincs, poliacetál

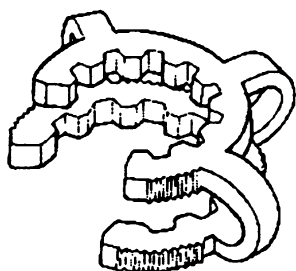

Kód	NS	Szín
28 663 61	10	zöld
28 663 62	12,5	lila
28 663 63	14,5	sárga
28 663 64	19	kék
28 663 65	24	zöld
28 663 66	29	piros
28 663 67	34	narancs
28 663 68	40	sárga
28 663 69	45	barna

Exszikkátor, gombos fedővel

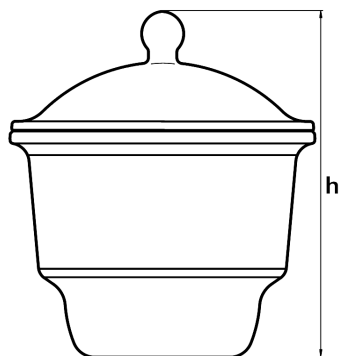

Kód	DN	h (mm)
24 781 46	100	187
24 781 57	150	252
24 781 61	200	309
24 781 66	250	357
24 781 69	300	433

Exszikkátor, NOVUS-féle csappal a fedőben

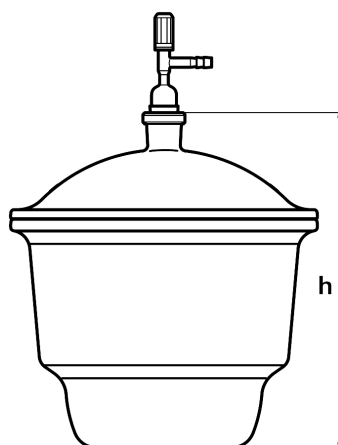

Kód	DN	h (mm)	NS
24 782 46	100	174	24/29
24 782 57	150	239	24/29
24 782 61	200	296	24/29
24 782 66	250	344	24/29
24 782 69	300	420	24/29

Exszikkátor, műanyag gombos fedővel, porcelán betéttel

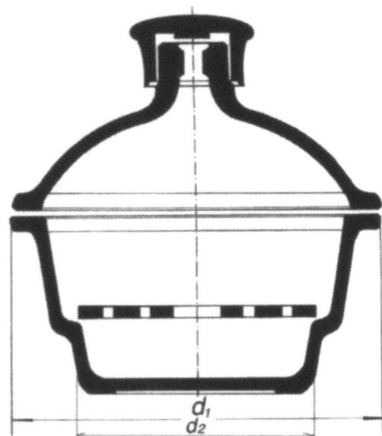

Kód	DN	d1 (mm)	d2 (mm)
24 783 46	100	151	90
24 783 57	150	210	140
24 783 61	200	269	190
24 783 66	250	329	240
24 783 69	300	392	290

Exszikkátor, műanyag gombos fedővel, üvegcsappal, porcelán betéttel

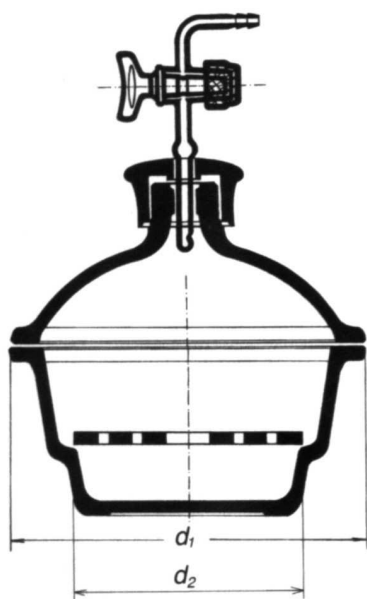

Kód	DN	d1 (mm)	d2 (mm)
24 784 46	100	151	90
24 784 57	150	210	140
24 784 61	200	269	190
24 784 66	250	329	240
24 784 69	300	392	290

Exszikkátor betét

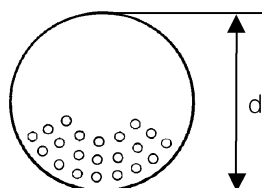

Porzellan/Porcelain

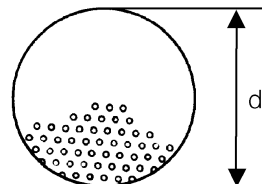

Metall/Metal

Kód fém	Kód porcelán	DN	d (mm)
29 080 46	29 725 46	100	90
29 080 57	29 725 57	150	140
29 080 61	29 725 61	200	185
29 080 66	29 725 66	250	235
29 080 69	29 725 69	300	280

Exszikkátor betét, porcelán

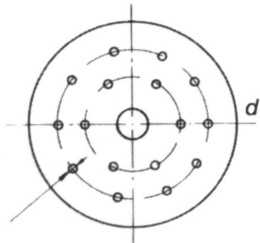

Kód	DN	d (mm)
29 726 46	100	90
29 726 57	150	140
29 726 61	200	189
29 726 66	250	241
29 726 69	300	291

Guko – sorozat

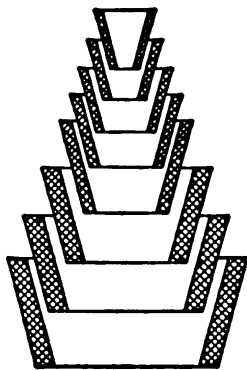

Kód	d (mm)
29 202 00	22-84